

Series CS1

Accessory Bracket Dimensions

I Type Single Knuckle Joint*

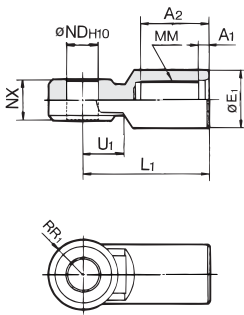

Material: Cast iron

Part no.	Applicable bore size (mm)	A ₁	A ₂	E ₁	L ₁	MM	ND _{H10}	NX	RR ₁	U ₁
I-12	125	8	54	46	100	M30 x 1.5	25 ^{+0.084} ₀	32 ^{-0.1} _{-0.3}	27	33
I-14	140	8	54	48	105	M30 x 1.5	28 ^{+0.084} ₀	36 ^{-0.1} _{-0.3}	30	39
I-16	160	8	60	55	110	M36 x 1.5	32 ^{+0.1} ₀	40 ^{-0.1} _{-0.3}	34	39
I-18	180	8	67	70	125	M40 x 1.5	40 ^{+0.1} ₀	50 ^{-0.1} _{-0.3}	42.5	44
I-20	200	8	67	70	125	M45 x 1.5	40 ^{+0.1} ₀	50 ^{-0.1} _{-0.3}	42.5	44
I-25	250	9	75.5	86	160	M56 x 2	50 ^{+0.1} ₀	63 ^{-0.1} _{-0.3}	53	66
I-30	300	9	84.5	105	175	M64 x 2	63 ^{+0.12} ₀	80 ^{-0.1} _{-0.3}	66	71

Knuckle Pin, Clevis Pin

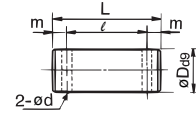

Material: Carbon steel

Part no.	Applicable bore size (mm)	Dd ₉	L	ℓ	m	d (Drill through)	Applicable cotter pin
IY-12	125	25 ^{-0.065} _{-0.117}	79.5	69.5	5	4	ø4 x 40
IY-14	140	28 ^{-0.065} _{-0.117}	86.5	76.5	5	4	ø4 x 40
IY-16	160	32 ^{-0.080} _{-0.142}	94.5	84.5	5	4	ø4 x 40
IY-18	180, 200	40 ^{-0.080} _{-0.142}	115	105	5	4	ø4 x 55
IY-25	250	50 ^{-0.080} _{-0.142}	144	132	6	5	ø5 x 65
IY-30	300	63 ^{-0.100} _{-0.174}	178	166	6	5	ø5 x 80

Y Type Double Knuckle Joint*

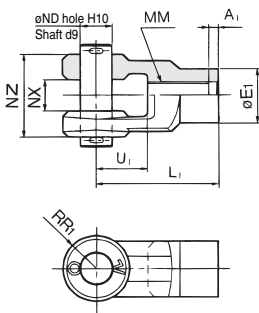

Material: Cast iron

Part no.	Applicable bore size (mm)	A ₁	E ₁	L ₁	MM	ND _{H10}	NX	NZ	RR ₁	U ₁
Y-12	125	8	46	100	M30 x 1.5	25 ^{+0.084} ₀	32 ^{+0.3} _{-0.1}	64 ^{-0.1} _{-0.3}	27	42
Y-14	140	8	48	105	M30 x 1.5	28 ^{+0.084} ₀	36 ^{+0.3} _{-0.1}	72 ^{-0.1} _{-0.3}	30	47
Y-16	160	8	55	110	M36 x 1.5	32 ^{+0.1} ₀	40 ^{+0.3} _{-0.1}	80 ^{-0.1} _{-0.3}	34	46
Y-18	180	8	70	125	M40 x 1.5	40 ^{+0.1} ₀	50 ^{+0.3} _{-0.1}	100 ^{-0.1} _{-0.3}	42.5	54
Y-20	200	8	70	125	M45 x 1.5	40 ^{+0.1} ₀	50 ^{+0.3} _{-0.1}	100 ^{-0.1} _{-0.3}	42.5	54
Y-25	250	9	86	160	M56 x 2	50 ^{+0.1} ₀	63 ^{+0.3} _{-0.1}	126 ^{-0.1} _{-0.3}	53	81
Y-30	300	9	105	175	M64 x 2	63 ^{+0.12} ₀	80 ^{+0.3} _{-0.1}	160 ^{-0.1} _{-0.3}	66	87

- * Use a single knuckle joint or a double knuckle joint individually. (Screw it entirely over the rod end threads and tighten it.)
- * Extend the dimensions of A, H, when using a single/double knuckle joint together with a rod end nut. (To extend dimensions A/H, refer to the table below, and specify the product as Made-to-order -XAO.)
- * Pin and cotter pin are attached for double knuckle joint.

Single/Double Knuckle Joint

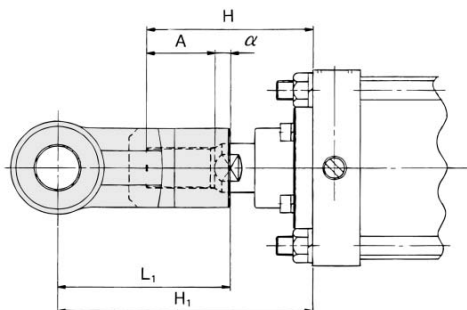

Symbol Bore size (mm)	H	A	α	L ₁	H ₁	Applicable knuckle joint part number	
						I type single knuckle	Y type double knuckle
125	110	50	3.5	100	156.5	I-12	Y-12
140	110	50	3.5	105	161.5	I-14	Y-14
160	120	56	3.5	110	170.5	I-16	Y-16
180, 200	135	63	3.5	125	193.5	I-18, I-20	Y-18, Y-20
250	160	71	3.5	160	245.5	I-25	Y-25
300	175	80	3.5	175	266.5	I-30	Y-30

A, H Dimensions when Mounting a Single/Double Knuckle Joint together with a Rod End Nut

Bore size (mm)	A	H
125	65	125
140	65	125
160	76	140
180	83	155
200	88	160
250	106	195
300	115	210

CJ1

CJP

CJ2

CM2

CG1

MB

MB1

CA2

CS1

C76

C85

C95

CP95

NCM

NCA

D-

-X

20-

Data

Dimensions for Accessories

Rod end nut
(Standard)

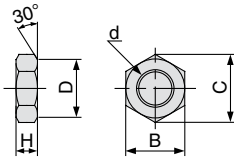

Part no.	Bore size (mm)	d	H	B	C	D
NT-03	32	M10 x 1.25	6	17	19.6	16.5
NT-04	40	M14 x 1.5	8	22	25.4	21
NT-05	50, 63	M18 x 1.5	11	27	31.2	26
NT-08	80	M22 x 1.5	13	32	37.0	31
NT-10	100	M26 x 1.5	16	41	47.3	39
NT-12M	125	M27 x 2.0	16	41	47.3	39

I type
Single knuckle
joint

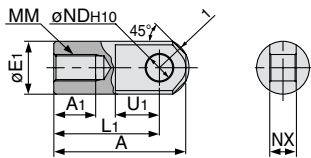

Part no.	Bore size (mm)	A	A ₁	E ₁	L ₁	MM	R ₁	U ₁	ND _{H10}	NX
I-03M	32	40	14	20	30	M10 x 1.25	12	16	10 ^{+0.058} ₀	14 ^{-0.10} _{-0.30}
I-04M	40	50	19	22	40	M14 x 1.5	12.5	19	10 ^{+0.058} ₀	14 ^{-0.10} _{-0.30}
I-05M	50, 63	64	24	28	50	M18 x 1.5	16.5	24	14 ^{+0.070} ₀	20 ^{-0.10} _{-0.30}
I-08M	80	80	26	40	60	M22 x 1.5	23.5	34	22 ^{+0.084} ₀	30 ^{-0.10} _{-0.30}
I-10M	100	80	26	40	60	M26 x 1.5	23.5	34	22 ^{+0.084} ₀	30 ^{-0.10} _{-0.30}
I-12M	125	119	36	46	92	M27 x 2.0	28.5	34	25 ^{+0.084} ₀	32 ^{-0.10} _{-0.30}

Knuckle joint pin
Clevis pin

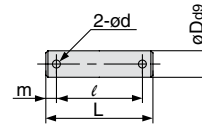

Part no.	Bore size (mm)		D _{as}	L	l	m	d (Through hole diameter)	Note 1) Applicable cotter pin
	Clevis	Knuckle						
CD-M03	32, 40	10	10 ^{-0.040} _{-0.076}	44	36	4	3	ø3 x 18 l
CD-M05	50, 63	14	14 ^{-0.050} _{-0.093}	60	51	4.5	4	ø4 x 25 l
CD-M08	80, 100	22	22 ^{-0.065} _{-0.117}	82	72	5	4	ø4 x 35 l
IY-12	125	25	25 ^{-0.065} _{-0.117}	79.5	69.5	5	4	ø4 x 40 l

Note 1) When using cotter pin, flat washer is used together.

Y type
Double knuckle
joint

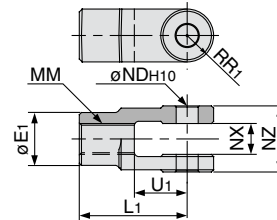

Part no.	Bore size (mm)	E ₁	L ₁	MM	R ₁	U ₁	ND _{H10}	NX	NZ
Y-03M	32	20	30	M10 x 1.25	10	16	10 ^{+0.058} ₀	14 ^{+0.30} _{+0.10}	28 ^{-0.10} _{-0.30}
Y-04M	40	22	40	M14 x 1.5	11	19	10 ^{+0.058} ₀	14 ^{+0.30} _{+0.10}	28 ^{-0.10} _{-0.30}
Y-05M	50, 63	28	50	M18 x 1.5	14	24	14 ^{+0.070} ₀	20 ^{+0.30} _{+0.10}	40 ^{-0.10} _{-0.30}
Y-08M	80	40	65	M22 x 1.5	20	34	22 ^{+0.084} ₀	30 ^{+0.30} _{+0.10}	60 ^{-0.10} _{-0.30}
Y-10M	100	40	65	M26 x 1.5	20	34	22 ^{+0.084} ₀	30 ^{+0.30} _{+0.10}	60 ^{-0.10} _{-0.30}
Y-12M	125	46	100	M27 x 2	27	42	25 ^{+0.084} ₀	32 ^{+0.30} _{+0.10}	64 ^{-0.10} _{-0.30}

Note) For a double clevis, a pin (cotter pin) and a flat washer are equipped as standard.

Combinations of Support Brackets

Available Combination..... Refer to below picture together.

Bracket for work Bracket for cylinder	Single clevis	Double clevis	Single knuckle joint	Double knuckle joint	Pivot bracket
Single clevis	—	①	—	②	—
Double clevis	③	—	④	—	⑨
Single knuckle joint	—	⑤	—	⑥	—
Double knuckle joint	⑦	—	⑧	—	⑩

No.	Appearance	No.	Appearance
①	Single clevis + Double clevis	⑥	Single knuckle joint + Double knuckle joint
②	Single clevis + Double knuckle joint	⑦	Double knuckle joint + Single clevis
③	Double clevis + Single clevis	⑧	Double knuckle joint + Single knuckle joint
④	Double clevis + Single knuckle joint	⑨	Double clevis + Pivot bracket
⑤	Single knuckle joint + Double clevis	⑩	Double knuckle joint + Pivot bracket

- CJ1
- CJP
- CJ2
- CM2
- CG1
- MB**
- MB1
- CA2
- CS1
- C76
- C85
- C95
- CP95
- NCM
- NCA
- D-
- X
- 20-
- Data

Series CM2

Accessory Bracket Dimensions

Single Knuckle Joint

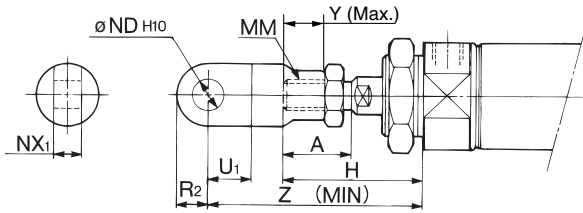

Bore size (mm)	A	H	MM	ND _{H10}	NX ₁	U ₁	R ₂	Y	Z
20	18	41	M8 x 1.25	9 ^{+0.058} ₀	9 ^{-0.1} _{-0.2}	14	10	11	66
25, 32	22	45	M10 x 1.25	9 ^{+0.058} ₀	9 ^{-0.1} _{-0.2}	14	10	14	69
40	24	50	M14 x 1.5	12 ^{+0.070} ₀	16 ^{-0.1} _{-0.3}	20	14	13	92

Double Knuckle Joint

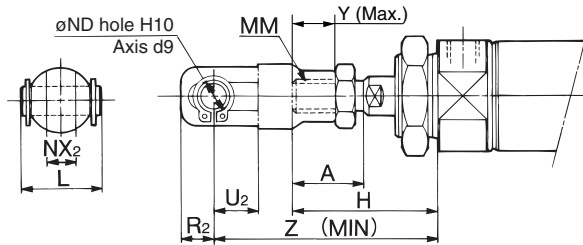

Bore size (mm)	A	H	L	MM	ND	NX ₂	R ₂	U ₂	Y	Z
20	18	41	25	M8 x 1.25	9	9 ^{+0.2} _{+0.1}	10	14	11	66
25, 32	22	45	25	M10 x 1.25	9	9 ^{+0.2} _{+0.1}	10	14	14	69
40	24	50	49.7	M14 x 1.5	12	16 ^{+0.3} _{+0.1}	13	25	13	92

Double Knuckle Joint

Y-020B, Y-032B Material: Rolled steel

Y-040B Material: Cast iron

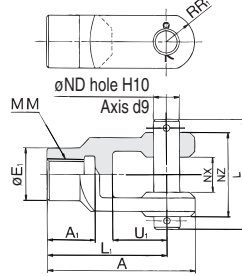
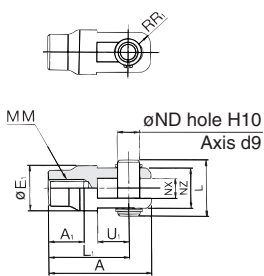

Part no.	Applicable bore size (mm)	A	A ₁	E ₁	L	L ₁	MM	ND	NX	NZ	R ₁	U ₁	Applicable pin part number	Snap ring Cotter pin size
Y-020B	20	46	16	20	25	36	M8 x 1.25	9	9 ^{+0.2} _{+0.1}	18	5	14	CDP-1	Type C9 for axis
Y-032B	25, 32	48	18	20	25	38	M10 x 1.25	9	9 ^{+0.2} _{+0.1}	18	5	14	CDP-1	Type C9 for axis
Y-040B	40	68	22	24	49.7	55	M14 x 1.5	12	16 ^{+0.3} _{+0.1}	38	13	25	CDP-3	ø3 x 18ℓ

* Clevis pin and snap ring (cotter pin for 40) are attached.

Double Clevis Pin / Material: Carbon steel

Bore size: ø20, ø25, ø32

CDP-1

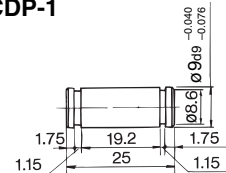

Snap ring: Type C9 for axis

Bore size: ø40

CDP-2

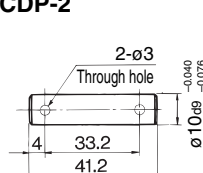

Cotter pin ø3 x 18ℓ

Double Knuckle Pin / Material: Carbon steel

Bore size: ø20, ø25, ø32

CDP-1

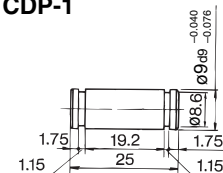

Snap ring: Type C9 for axis

Bore size: ø40

CDP-3

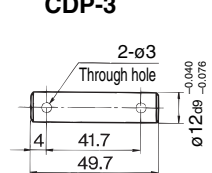

Cotter pin ø3 x 18ℓ

Single Knuckle Joint

I-020B/032B Material: Rolled steel

I-040B Material: Free cutting sulfur steel

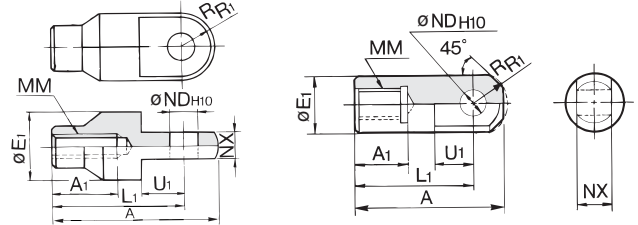

Part no.	Applicable bore size (mm)	A	A ₁	E ₁	L ₁	MM	ND _{H10}	NX	R ₁	U ₁
I-020B	20	46	16	20	36	M8 x 1.25	9 ^{+0.058} ₀	9 ^{-0.1} _{-0.2}	10	14
I-032B	25, 32	48	18	20	38	M10 x 1.25	9 ^{+0.058} ₀	9 ^{-0.1} _{-0.2}	10	14
I-040B	40	69	22	24	55	M14 x 1.5	12 ^{+0.070} ₀	16 ^{-0.1} _{-0.3}	15.5	20

CJ1

CJP

CJ2

CM2

CG1

MB

MB1

CA2

CS1

C76

C85

C95

CP95

NCM

NCA

D-

-X

20-

Data

Series CQ2

Accessory Bracket

Single Knuckle Joint

For I-G012, I-Z015A
I-G02, I-G03

For I-G04, I-G05
I-G08, I-G10

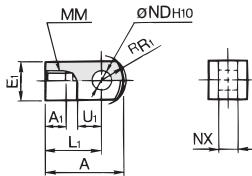

Material: Carbon steel

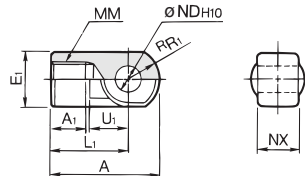

Material: Cast iron

Double Knuckle Joint

For Y-G012, Y-Z015A
Y-G02, Y-G03

For Y-G04, Y-G05
Y-G08, Y-G10

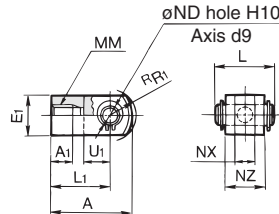

Material: Carbon steel

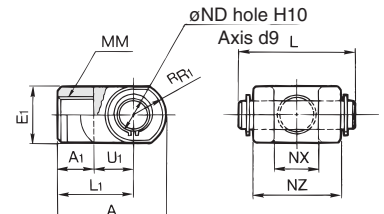

Material: Cast iron

Part no.	Applicable bore size (mm)	A	A ₁	E ₁	L ₁	MM	R _{R1}	U ₁	ND _{H10}	NX
I-G012	12	21.5	6	□10	16	M5 x 0.8	6.3	7	5 ^{+0.048} ₀	5 ^{-0.2} _{-0.4}
I-Z015A	16	32	8	□12	25	M6 x 1	8.1	14	5 ^{+0.048} ₀	6.4 ^{-0.1} _{-0.3}
I-G02	20	34	8.5	□16	25	M8 x 1.25	10.3	11.5	8 ^{+0.058} ₀	8 ^{-0.2} _{-0.4}
I-G03	25	41	10.5	□20	30	M10 x 1.25	12.8	14	10 ^{+0.058} ₀	10 ^{-0.2} _{-0.4}
I-G04	32, 40	42	14	ø22	30	M14 x 1.5	12	14	10 ^{+0.058} ₀	18 ^{-0.3} _{-0.5}
I-G05	50, 63	56	18	ø28	40	M18 x 1.5	16	20	14 ^{+0.070} ₀	22 ^{-0.3} _{-0.5}
I-G08	80	71	21	ø38	50	M22 x 1.5	21	27	18 ^{+0.070} ₀	28 ^{-0.3} _{-0.5}
I-G10	100	79	21	ø44	55	M26 x 1.5	24	31	22 ^{+0.084} ₀	32 ^{-0.3} _{-0.5}

Part no.	Applicable bore size (mm)	A	A ₁	E ₁	L ₁	MM	R _{R1}	U ₁	ND _{H10}	NX	NZ	L	Applicable pin part no.
Y-G012	12	21.5	6	□10	16	M5 x 0.8	6.3	7	5 ^{+0.048} ₀	5 ^{-0.4} _{-0.2}	10	14.6	IY-G012
Y-Z015A	16	28	11	□12	21	M6 x 1	8.1	10	5 ^{+0.048} ₀	6.5 ^{-0.2} _{-0.2}	12	16.6	IY-J015
Y-G02	20	34	8.5	□16	25	M8 x 1.25	10.3	11.5	8 ^{+0.058} ₀	8 ^{-0.4} _{-0.2}	16	21	IY-G02
Y-G03	25	41	10.5	□20	30	M10 x 1.25	12.8	14	10 ^{+0.058} ₀	10 ^{-0.4} _{-0.2}	20	25.6	IY-G03
Y-G04	32, 40	42	16	ø22	30	M14 x 1.5	12	14	10 ^{+0.058} ₀	18 ^{-0.5} _{-0.3}	36	41.6	IY-G04
Y-G05	50, 63	56	20	ø28	40	M18 x 1.5	16	20	14 ^{+0.070} ₀	22 ^{-0.5} _{-0.3}	44	50.6	IY-G05
Y-G08	80	71	23	ø38	50	M22 x 1.5	21	27	18 ^{+0.070} ₀	28 ^{-0.5} _{-0.3}	56	64	IY-G08
Y-G10	100	79	24	ø44	55	M26 x 1.5	24	31	22 ^{+0.084} ₀	32 ^{-0.5} _{-0.3}	64	72	IY-G10

* Knuckle pin and snap ring are included.

Knuckle Pin (Common with double clevis pin)

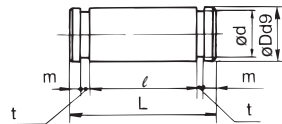

Material: Carbon steel

Part no.	Applicable bore size (mm)	Dd9	L	d	l	m	t	Applicable snap ring
IY-G012	12	5 ^{-0.030} _{-0.060}	14.6	4.8	10.2	1.5	0.7	Type C 5 for axis
IY-J015	16	5 ^{-0.030} _{-0.060}	16.6	4.8	12.2	1.5	0.7	Type C 5 for axis
IY-G02	20	8 ^{-0.040} _{-0.076}	21	7.6	16.2	1.5	0.9	Type C 8 for axis
IY-G03	25	10 ^{-0.040} _{-0.076}	25.6	9.6	20.2	1.55	1.15	Type C 10 for axis
IY-G04	32, 40	10 ^{-0.040} _{-0.076}	41.6	9.6	36.2	1.55	1.15	Type C 10 for axis
IY-G05	50, 63	14 ^{-0.050} _{-0.093}	50.6	13.4	44.2	2.05	1.15	Type C 14 for axis
IY-G08	80	18 ^{-0.050} _{-0.093}	64	17	56.2	2.55	1.35	Type C 18 for axis
IY-G10	100	22 ^{-0.065} _{-0.117}	72	21	64.2	2.55	1.35	Type C 22 for axis

Rod End Nut

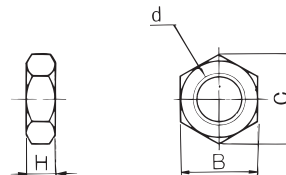

Material: Carbon steel

Part no.	Applicable bore size (mm)	d	H	B	C
NTJ-015A	12	M5 x 0.8	4	8	9.2
NT-015A	16	M6 x 1	5	10	11.5
NT-02	20	M8 x 1.25	5	13	15.0
NT-03	25	M10 x 1.25	6	17	19.6
NT-04	32, 40	M14 x 1.5	8	22	25.4
NT-05	50, 63	M18 x 1.5	11	27	31.2
NT-08	80	M22 x 1.5	13	32	37.0
NT-10	100	M26 x 1.5	16	41	47.3

Series CG1

Accessory Bracket Dimensions

Single Knuckle Joint

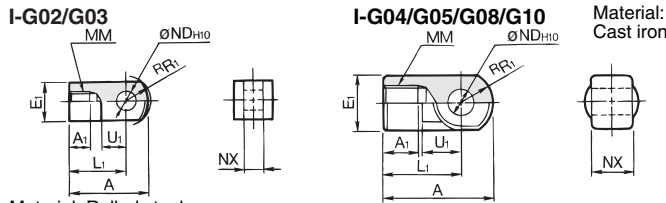

Material: Rolled steel

Part no.	Applicable bore (mm)	A	A ₁	E ₁	L ₁	MM	R ₁	U ₁	ND _{H10}	NX
I-G02	20	34	8.5	□16	25	M8 x 1.25	10.3	11.5	8 ^{+0.058} ₀	8 ^{-0.2} _{-0.4}
I-G03	25, 32	41	10.5	□20	30	M10 x 1.25	12.8	14	10 ^{+0.058} ₀	10 ^{-0.2} _{-0.4}
I-G04	40	42	14	∅22	30	M14 x 1.5	12	14	10 ^{+0.058} ₀	18 ^{-0.3} _{-0.5}
I-G05	50, 63	56	18	∅28	40	M18 x 1.5	16	20	14 ^{+0.070} ₀	22 ^{-0.3} _{-0.5}
I-G08	80	71	21	∅38	50	M22 x 1.5	21	27	18 ^{+0.070} ₀	28 ^{-0.3} _{-0.5}
I-G10	100	79	21	∅44	55	M26 x 1.5	24	31	22 ^{+0.084} ₀	32 ^{-0.3} _{-0.5}

Knuckle Pin

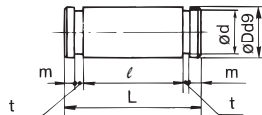

Material: Carbon steel

Part no.	Applicable bore (mm)	Dd ₉	L	d	ℓ	m	t	Applicable snap ring
IY-G02	20	8 ^{-0.040} _{-0.076}	21	7.6	16.2	1.5	0.9	Type C 8 for axis
IY-G03	25, 32	10 ^{-0.040} _{-0.076}	25.6	9.6	20.2	1.55	1.15	Type C 10 for axis
IY-G04	40	10 ^{-0.040} _{-0.076}	41.6	9.6	36.2	1.55	1.15	Type C 10 for axis
IY-G05	50, 63	14 ^{-0.050} _{-0.093}	50.6	13.4	44.2	2.05	1.15	Type C 14 for axis
IY-G08	80	18 ^{-0.050} _{-0.093}	64	17	56.2	2.55	1.35	Type C 18 for axis
IY-G10	100	22 ^{-0.065} _{-0.117}	72	21	64.2	2.55	1.35	Type C 22 for axis

Clevis Pin

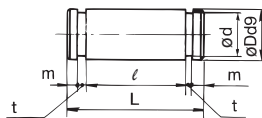

Material: Carbon steel

Part no.	Applicable bore (mm)	Dd ₉	L	d	ℓ	m	t	Applicable snap ring
CD-G02	20	8 ^{-0.040} _{-0.076}	43.4	7.6	38.6	1.5	0.9	Type C 8 for axis
CD-G25	25	10 ^{-0.040} _{-0.076}	48	9.6	42.6	1.55	1.15	Type C 10 for axis
CD-G03	32	12 ^{-0.050} _{-0.093}	59.4	11.5	54	1.55	1.15	Type C 12 for axis
CD-G04	40	14 ^{-0.050} _{-0.093}	71.4	13.4	65	2.05	1.15	Type C 14 for axis
CD-G05	50	16 ^{-0.050} _{-0.093}	86	15.2	79.6	2.05	1.15	Type C 16 for axis
CD-G06	63	18 ^{-0.050} _{-0.093}	105.4	17	97.8	2.45	1.35	Type C 18 for axis

* Clevis pin and knuckle pin are common for bore size ∅80 and ∅100.

Rod End Nut

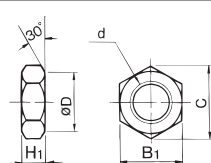

Material: Rolled steel

Part no.	Applicable bore (mm)	d	H ₁	B ₁	C	D
NT-02	20	M8 x 1.25	5	13	(15.0)	12.5
NT-03	25, 32	M10 x 1.25	6	17	(19.6)	16.5
NT-G04	40	M14 x 1.5	8	19	(21.9)	18
NT-05	50, 63	M18 x 1.5	11	27	(31.2)	26
NT-08	80	M22 x 1.5	13	32	(37.0)	31
NT-10	100	M26 x 1.5	16	41	(47.3)	39

Double Knuckle Joint

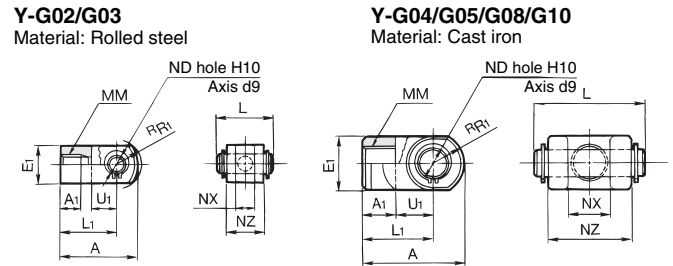

Part no.	Applicable bore (mm)	A	A ₁	E ₁	L ₁	MM	R ₁	U ₁	ND	NX	NZ	L	Applicable pin part no.
Y-G02	20	34	8.5	□16	25	M8 x 1.25	10.3	11.5	8	8 ^{+0.4} _{-0.2}	16	21	IY-G02
Y-G03	25, 32	41	10.5	□20	30	M10 x 1.25	12.8	14	10	10 ^{+0.4} _{-0.2}	20	25.6	IY-G03
Y-G04	40	42	16	∅22	30	M14 x 1.5	12	14	10	18 ^{+0.5} _{-0.3}	36	41.6	IY-G04
Y-G05	50, 63	56	20	∅28	40	M18 x 1.5	16	20	14	22 ^{+0.5} _{-0.3}	44	50.6	IY-G05
Y-G08	80	71	23	∅38	50	M22 x 1.5	21	27	18	28 ^{+0.5} _{-0.3}	56	64	IY-G08
Y-G10	100	79	24	∅44	55	M26 x 1.5	24	31	22	32 ^{+0.5} _{-0.3}	64	72	IY-G10

* Knuckle pin and set ring are shipped together.

Pivot Bracket (Order separately)

∅20 to ∅63

Material: Rolled steel

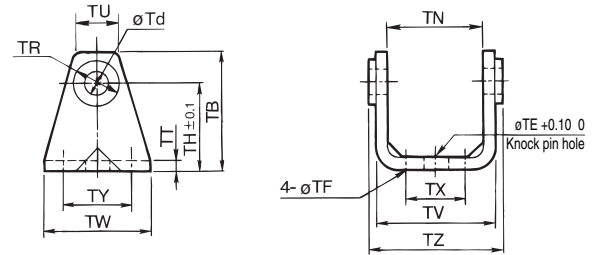

∅80, ∅100

Material: Cast iron

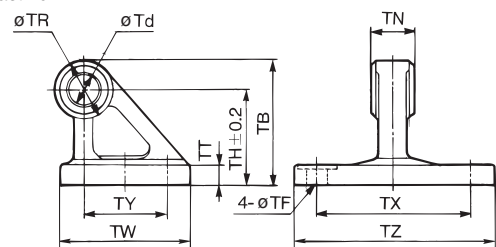

Part no.	Applicable bore (mm)	TB	Td	TE	TF	TH	TN	TR	TT
CG-020-24A	20	36	8	10	5.5	25	(29.3)	13	3.2
CG-025-24A	25	43	10	10	5.5	30	(33.1)	15	3.2
CG-032-24A	32	50	12	10	6.6	35	(40.4)	17	4.5
CG-040-24A	40	58	14	10	6.6	40	(49.2)	21	4.5
CG-050-24A	50	70	16	20	9	50	(60.4)	24	6
CG-063-24A	63	82	18	20	11	60	(74.6)	26	8
CG-080-24A	80	73	18	—	11	55	28 ^{+0.1} _{-0.3}	36	11
CG-100-24A	100	90	22	—	13.5	65	32 ^{+0.1} _{-0.3}	50	12

Part no.	Applicable bore (mm)	TU	TV	TW	TX	TY	TZ	Applicable pin O.D.
CG-020-24A	20	(18.1)	(35.8)	42	16	28	38.3	8d ₉ ^{-0.040} _{-0.076}
CG-025-24A	25	(20.7)	(39.8)	42	20	28	42.1	10d ₉ ^{-0.040} _{-0.076}
CG-032-24A	32	(23.6)	(49.4)	48	22	28	53.8	12d ₉ ^{-0.050} _{-0.093}
CG-040-24A	40	(27.3)	(58.4)	56	30	30	64.6	14d ₉ ^{-0.050} _{-0.093}
CG-050-24A	50	(29.7)	(72.4)	64	36	36	79.2	16d ₉ ^{-0.050} _{-0.093}
CG-063-24A	63	(34.3)	(90.4)	74	46	46	97.2	18d ₉ ^{-0.050} _{-0.093}
CG-080-24A	80	—	—	72	85	45	110	18d ₉ ^{-0.050} _{-0.093}
CG-100-24A	100	—	—	93	100	60	130	22d ₉ ^{-0.065} _{-0.117}

Accessory Bracket Dimensions

Single Knuckle Joint

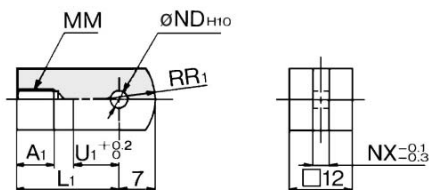

Material: Rolled steel

Part no.	Applicable bore (mm)	A ₁	L ₁	MM	ND ^{H10}	NX	R ₁	U ₁
I-J010B	10	8	21	M4 x 0.7	3.3 $^{+0.048}_0$	3.1	8	9
I-J016B	16	8	25	M5 x 0.8	5.3 $^{+0.048}_0$	6.4	12	14

Double Knuckle Joint

* Knuckle pin and set ring are shipped together.

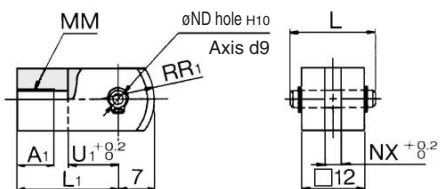

Material: Rolled steel

Part no.	Applicable bore (mm)	A ₁	L	L ₁	MM
Y-J010B	10	8	15.2	21	M4 x 0.7
Y-J016B	16	11	16.6	21	M5 x 0.8

Part no.	ND _{d9}	ND ^{H10}	NX	R ₁	U ₁
Y-J010B	3.3 $^{+0.030}_0$	3.3 $^{+0.048}_0$	3.2	8	10
Y-J016B	5.3 $^{+0.030}_0$	5.3 $^{+0.048}_0$	6.5	12	10

T-bracket

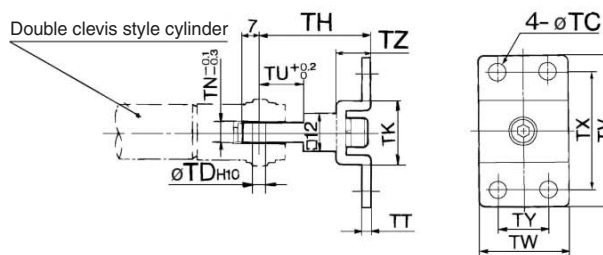

Part no.	Applicable bore (mm)	TC	TD ^{H10}	TH	TK	TN	TT	TU	TV	TW	TX	TY	TZ
CJ-T010B	10	4.5	3.3 $^{+0.048}_0$	29	18	3.1	2	9	40	22	32	12	8
CJ-T016B	16	5.5	5 $^{+0.048}_0$	35	20	6.4	2.3	14	48	28	38	16	10

Clevis Pin

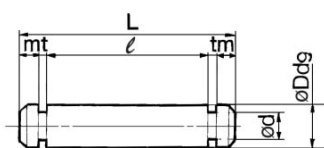

Material: Stainless steel

Part no.	Applicable bore (mm)	Dd ₉	d	L	ℓ	m	t	Applicable snap ring
CD-J010	10	3.3 $^{+0.030}_0$	3	15.2	12.2	1.2	0.3	Type C 3.2
CD-Z015	16	5.3 $^{+0.030}_0$	4.8	22.7	18.3	1.5	0.7	Type C 5
CD-JA010*	10	3.3 $^{+0.030}_0$	3	18.2	15.2	1.2	0.3	Type C 3.2

* For ø10 double clevis style, with air cushion and built-in speed controller.

Mounting Nut

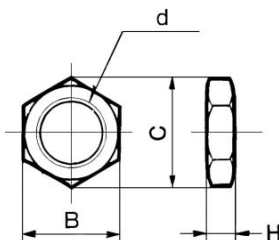

Material: Brass

Part no.	Applicable bore (mm)	B	C	d	H
SNJ-006B	6	8	9.2	M6 x 1.0	4
SNJ-010B	10	11	12.7	M8 x 1.0	4
SNJ-016B	16	14	16.2	M10 x 1.0	4
SNKJ-016B*	16	17	19.6	M12 x 1.0	4

* For ø16 non-rotating type. (Use SNJ-016B for ø10 non-rotating type.)

Knuckle Pin

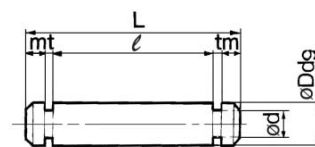

Material: Stainless steel

Part no.	Applicable bore (mm)	Dd ₉	d	L	ℓ	m	t	Applicable snap ring
CD-J010	10	3.3 $^{+0.030}_0$	3	15.2	12.2	1.2	0.3	Type C 3.2
IY-J015	16	5.3 $^{+0.030}_0$	4.8	16.6	12.2	1.5	0.7	Type C 5

* For size ø10, clevis pin is diverted.

Rod End Nut

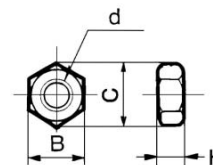

Material: Iron

Part no.	Applicable bore (mm)	B	C	d	H
NTJ-006A	6	5.5	6.4	M3 x 0.5	2.4
NTJ-010A	10	7	8.1	M4 x 0.7	3.2
NTJ-015A	16	8	9.2	M5 x 0.8	4

Rod End Cap

Flat type/CJ-CF□□□

Round type/CJ-CR□□□

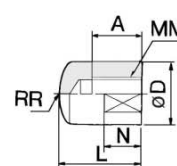
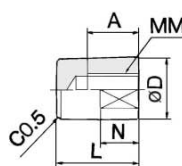

Material: Polyacetal

Part no.		Applicable bore (mm)	A	D	L	MM	N	R	W
Flat type	Round type								
CJ-CF006	CJ-CR006	6	6	8	11	M3 x 0.5	5	8	6
CJ-CF010	CJ-CR010	10	8	10	13	M4 x 0.7	6	10	8
CJ-CF016	CJ-CR016	16	10	12	15	M5 x 0.8	7	12	10

- CJ1
- CJP
- CJ2**
- CM2
- CG1
- MB
- MB1
- CA2
- CS1
- C76
- C85
- C95
- CP95
- NCM
- NCA
- D-
- X
- 20-
- Data

Trunnion Style

CJPT/Without auto switch

Mounting dimensions of trunnion pivot bracket

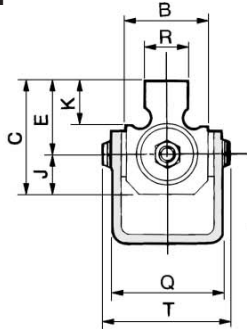
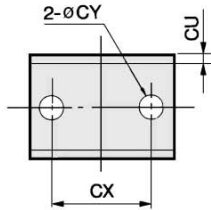

Rod end nut
(Refer to accessory bracket dimensions.)

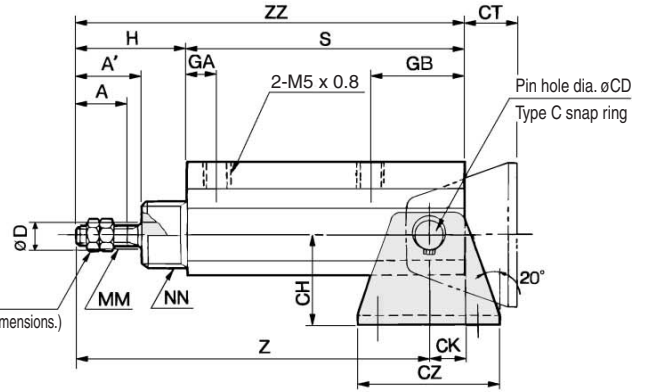

Symbol	A	A'	B	C	D	E	GA	GB	H	J	K	MM	NN	Q	T	CD	CH	CK	CT	CU	CX	CY	CZ
6	7	9	14	16.5	3	10.5	6	11	17	6	8	M3 x 0.5	M10 x 1.0	18.5	20.4	3	16	4	12	1.6	18	3.4	26
10	10	12	15	20	5	13	6	17	20	7	8	M4 x 0.7	M12 x 1.0	20.5	23.9	5	20	6.5	13.5	1.6	24	4.5	33
15	12	14	20	24.5	6	15.5	6	18.5	24	9	8	M5 x 0.8	M14 x 1.0	28	31.7	6	25	8	17	2.9	29	5.5	42

Symbol	S					Z					ZZ					R
	5 st	10 st	15 st	20 st	30 st	5 st	10 st	15 st	20 st	30 st	5 st	10 st	15 st	20 st	30 st	
6	35.5	40.5	45.5	50.5	—	48.5	53.5	58.5	63.5	—	52.5	57.5	62.5	67.5	—	7
10	40.5	45.5	50.5	55.5	65.5	54	59	64	69	79	60.5	65.5	70.5	75.5	85.5	8
15	42	47	52	57	67	58	63	68	73	83	66	71	76	81	91	10

Accessory Bracket Dimensions

Single knuckle joint

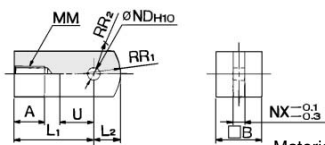

Material: Rolled steel

Part no.	Applicable bore (mm)	A	B	L ₁	L ₂	MM	ND _{H10}	NX	R ₁	R ₂	U
I-P006	6	5	6	12	3.5	M3 x 0.5	3 ^{+0.040}	3	5	4	5
I-P010	10	6.5	10	16	5.5	M4 x 0.7	5 ^{+0.048}	5	8	6.3	7
I-P015	15	7	12	19	7	M5 x 0.8	6 ^{+0.048}	6	10	7.8	9

Knuckle pin

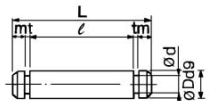

Material: Stainless steel

Part no.	Applicable bore (mm)	D ø9	L	d	ℓ	m	t	Snap ring
IY-P006	6	3 ^{-0.020} _{-0.045}	9	2.85	6.2	0.75	0.65	Clip type C3
IY-P010	10	5 ^{-0.030} _{-0.060}	13.6	4.8	10.2	1	0.7	Type C 5
IY-P015	15	6 ^{-0.030} _{-0.060}	15.8	5.7	12.2	1	0.8	Type C 6

Mounting nut

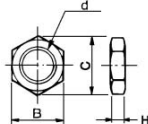

Material: Brass

Part no.	Applicable bore (mm)	d	H	B	C
SNP-006	6	M10 x 1.0	3	14	16.2
SNP-010	10	M12 x 1.0	3	17	19.6
SNP-015	15	M14 x 1.0	4	19	21.9

Rod end nut

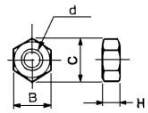

Material: Iron

Part no.	Applicable bore (mm)	d	H	B	C
NTP-006	6	M3 x 0.5	1.8	5.5	6.4
NTP-010	10	M4 x 0.7	2.4	7	8.1
NTP-015	15	M5 x 0.8	3.2	8	9.2

Double knuckle joint

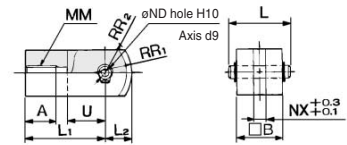

* Knuckle pin and set ring are shipped together.

Material: Rolled steel

Part no.	Applicable bore (mm)	A	B	L	L ₁	L ₂	MM	ND _{d9}	ND _{H10}	NX	R ₁	R ₂	U
Y-P006	6	5	6	9	12	3.5	M3 x 0.5	3 ^{-0.020} _{-0.045}	3 ^{+0.040} ₀	3	5	4	5
Y-P010	10	6.5	10	13.6	16	5.5	M4 x 0.7	5 ^{-0.030} _{-0.060}	5 ^{+0.048} ₀	5	8	6.3	7
Y-P015	15	7	12	15.8	19	7	M5 x 0.8	6 ^{-0.030} _{-0.060}	6 ^{+0.048} ₀	6	10	7.8	9

Trunnion pin

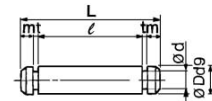

Material: Stainless steel

Part no.	Applicable bore (mm)	D ø9	L	d	ℓ	m	t	Snap ring
CT-P006	6	3 ^{-0.020} _{-0.045}	20.4	2.85	17.6	0.75	0.65	Clip type C3
CT-P010	10	5 ^{-0.030} _{-0.060}	23.9	4.8	20.5	1	0.7	Type C 5
CT-P015	15	6 ^{-0.030} _{-0.060}	31.7	5.7	28.1	1	0.8	Type C 6

Rod end cap

Flat type/CJ-CF□□□ Round type/CJ-CR□□□

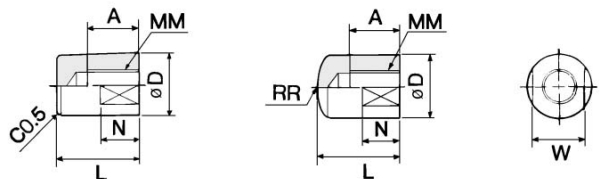

Material: Polyacetal

Part no.	Applicable bore (mm)	A	D	L	MM	N	R	W	
Flat type	Round type								
CJ-CF006	CJ-CR006	6	6	8	11	M3 x 0.5	5	8	6
CJ-CF010	CJ-CR010	10	8	10	13	M4 x 0.7	6	10	8
CJ-CF016	CJ-CR016	15	10	12	15	M5 x 0.8	7	12	10